

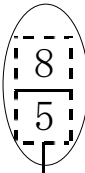

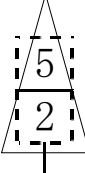







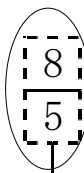
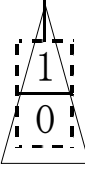
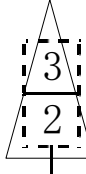

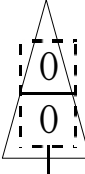
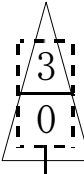
# 剣 道

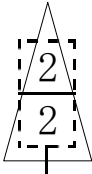
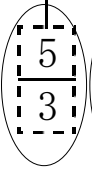
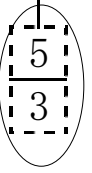
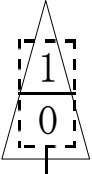
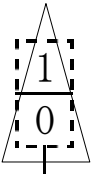
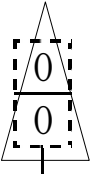
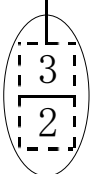
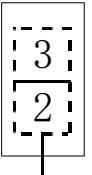
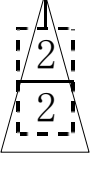
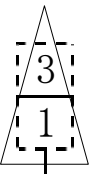
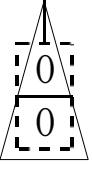
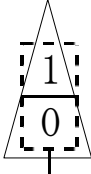
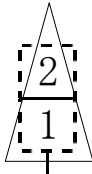
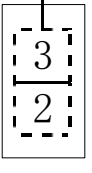
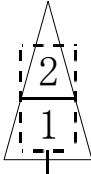
## 【団体戦・リーグ戦（5日）】

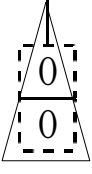
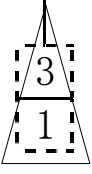
第1試合場 9:30												勝 数	勝 者 数	総 本 数	順 位
順 序															
第2試合場															
順 序															
A	仙台名取											5	24	39	1
B	一 関											2	8	17	4
C	八 戸											2	8	14	5
D	福 島											1.5	7	12	7
E	秋 田											1.5	9	16	6
F	鶴 岡											5	22	36	2
G	仙台広瀬											4	18	32	3

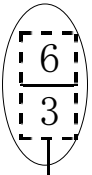
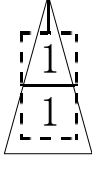
第1位 仙台名取

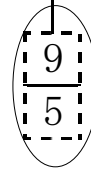
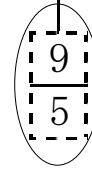
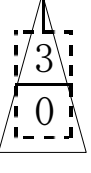
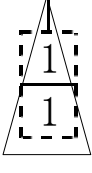
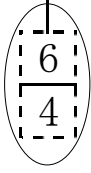
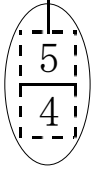
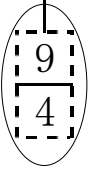
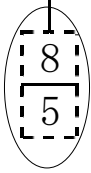
第2位 鶴 岡

第3位 仙台広瀬

【 男子個人戦(6日) 】

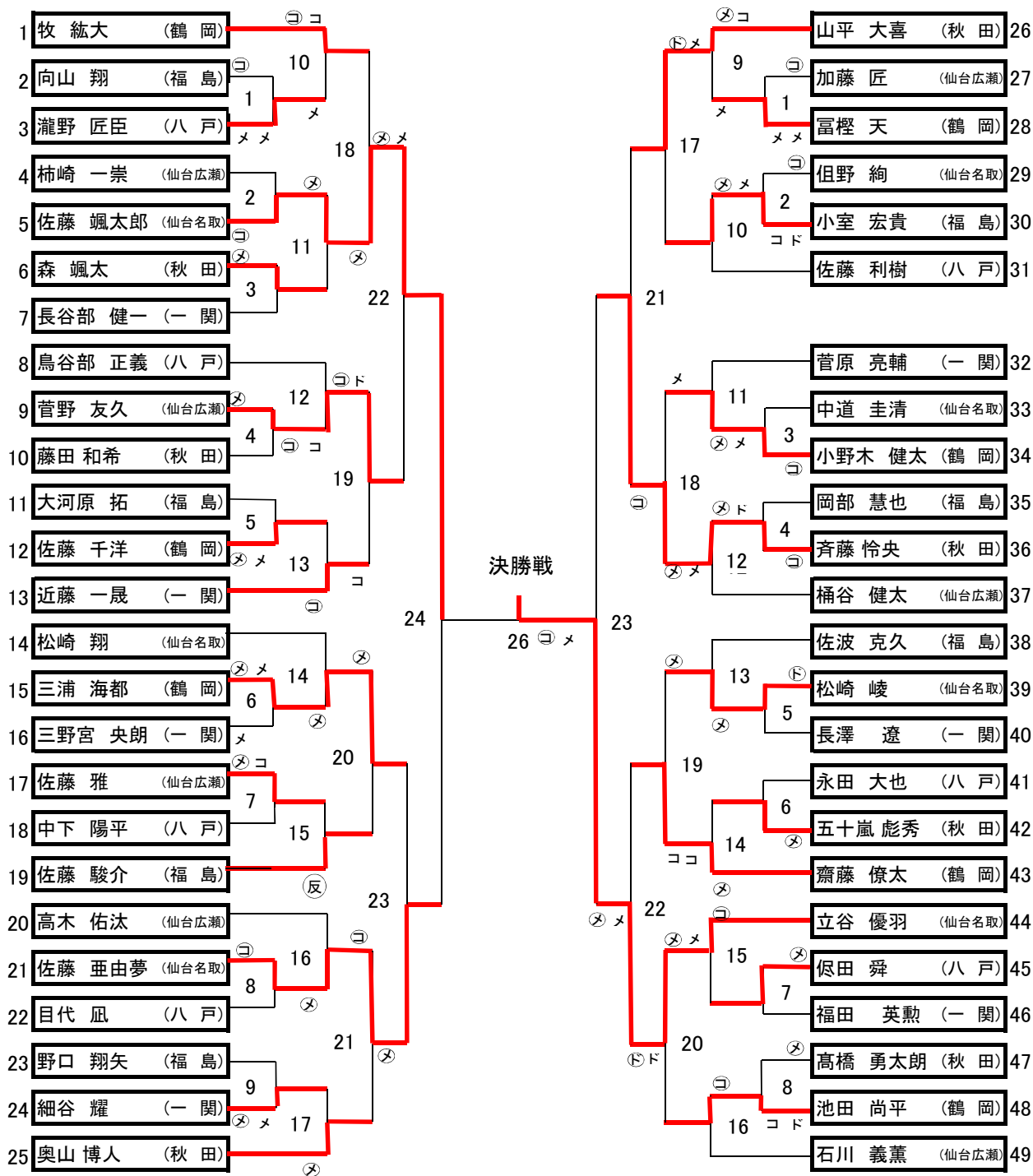

- |     |              |     |               |     |               |
|-----|--------------|-----|---------------|-----|---------------|
| 第1位 | 立谷 優羽 (仙台名取) | 第2位 | 佐藤 颯太郎 (仙台名取) | 第3位 | 斉藤 怜央 (秋田)    |
|     |              |     |               | 第4位 | 佐藤 亜由夢 (仙台名取) |

【女子個人戦（5日）】

